

+

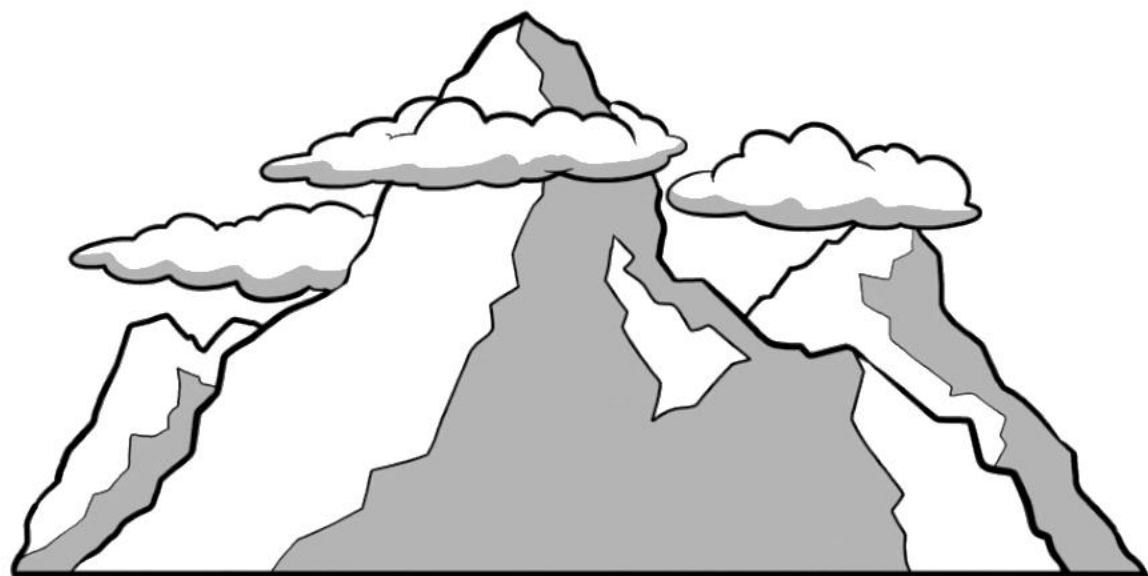

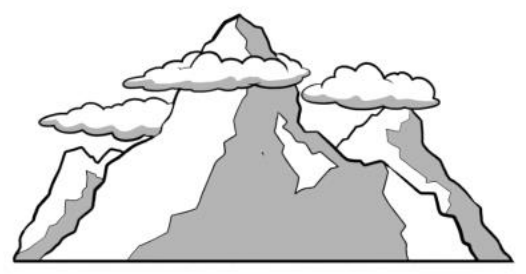

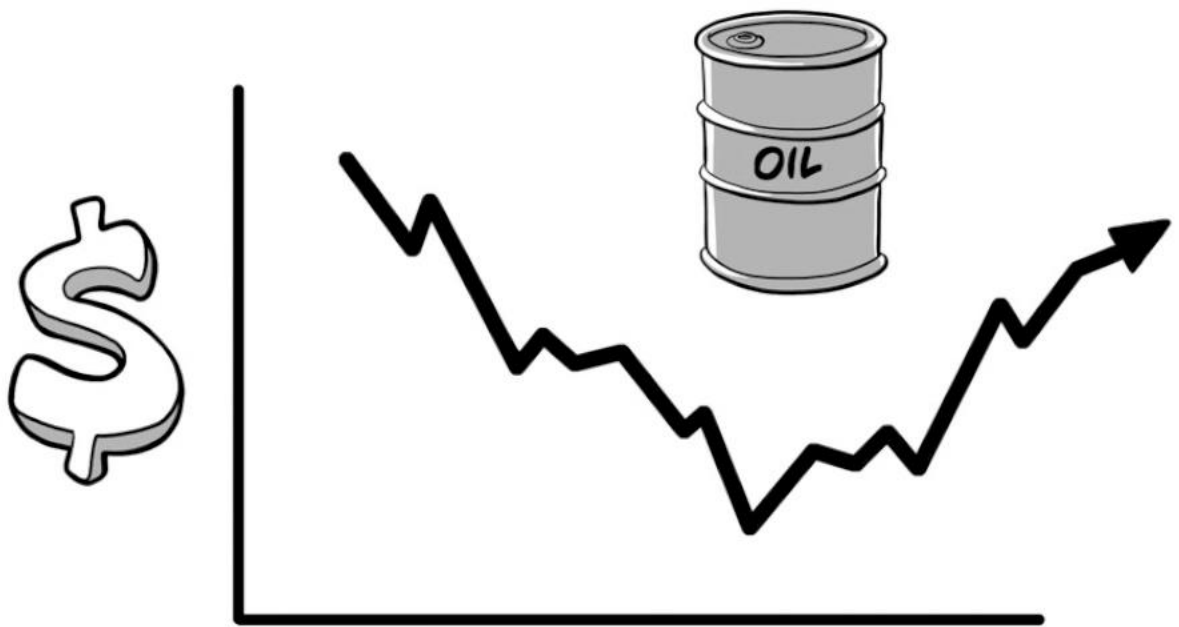

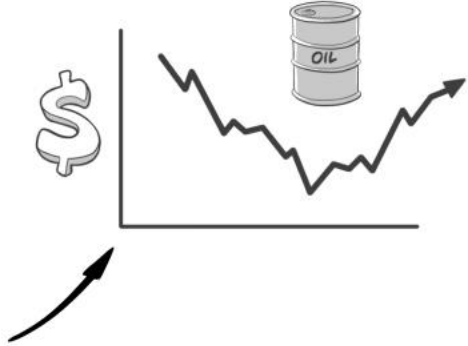
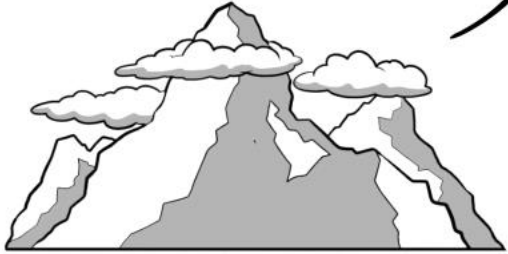
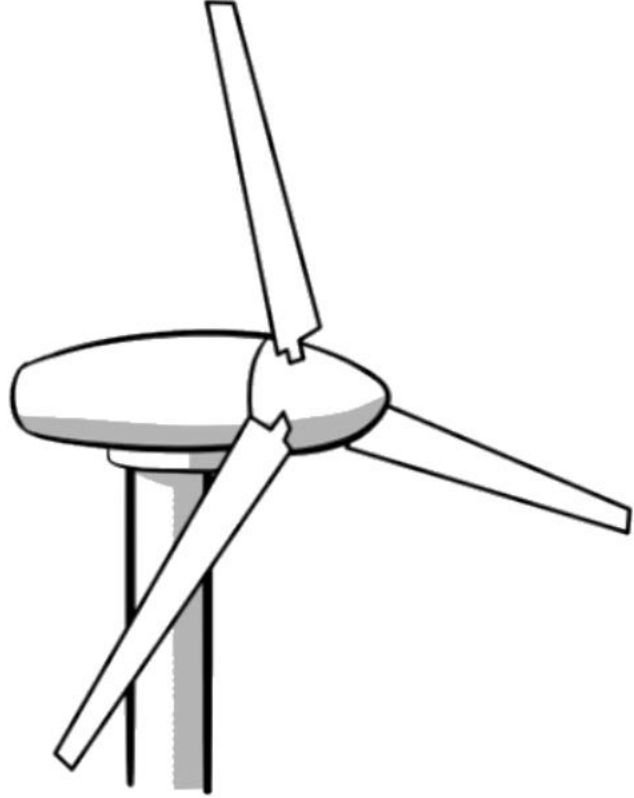
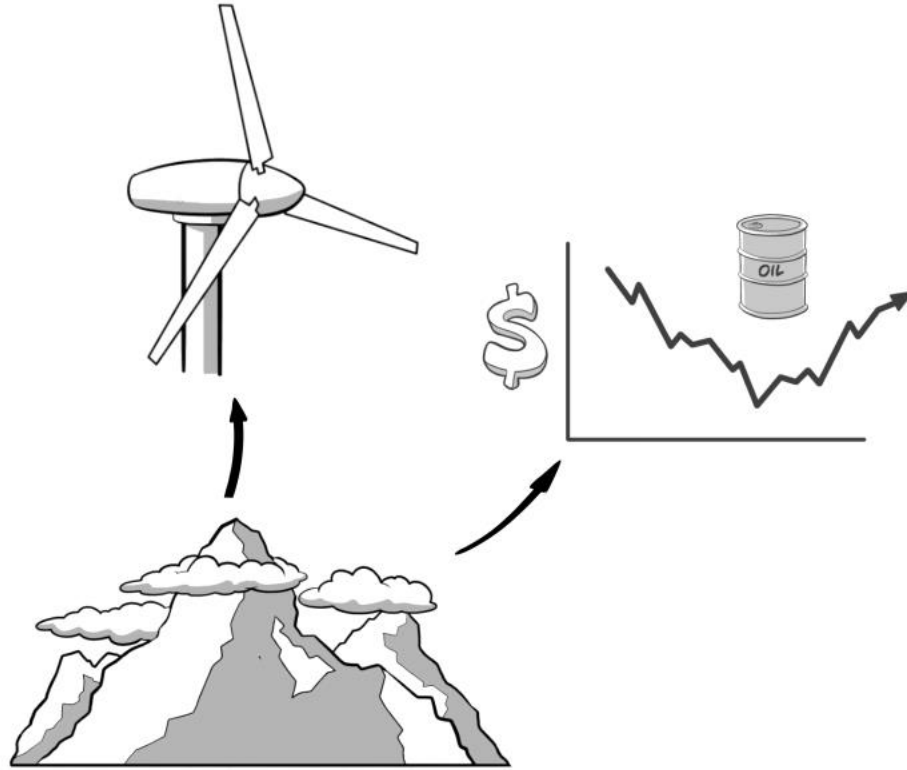
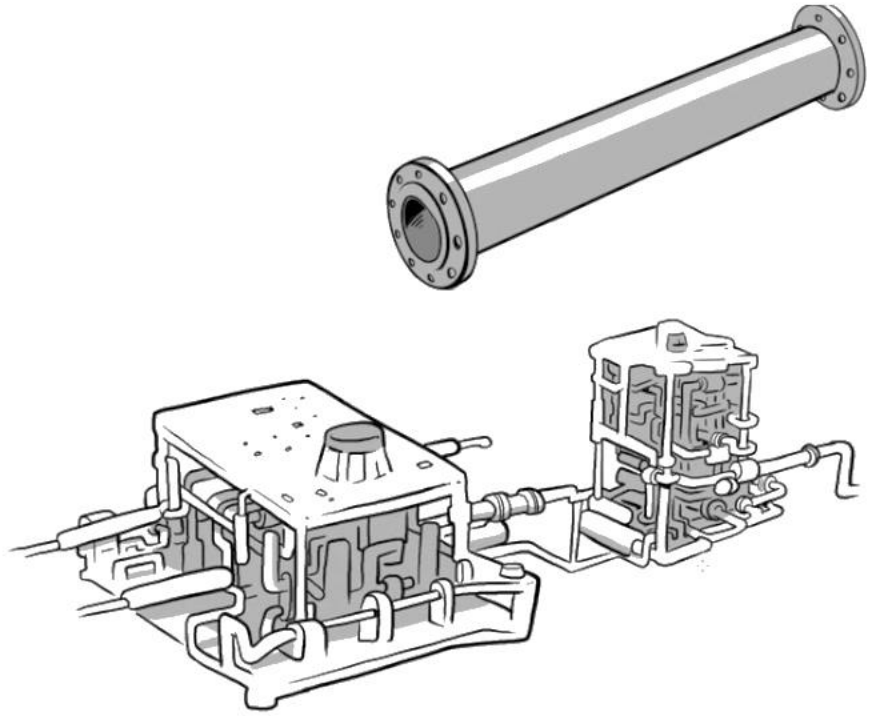

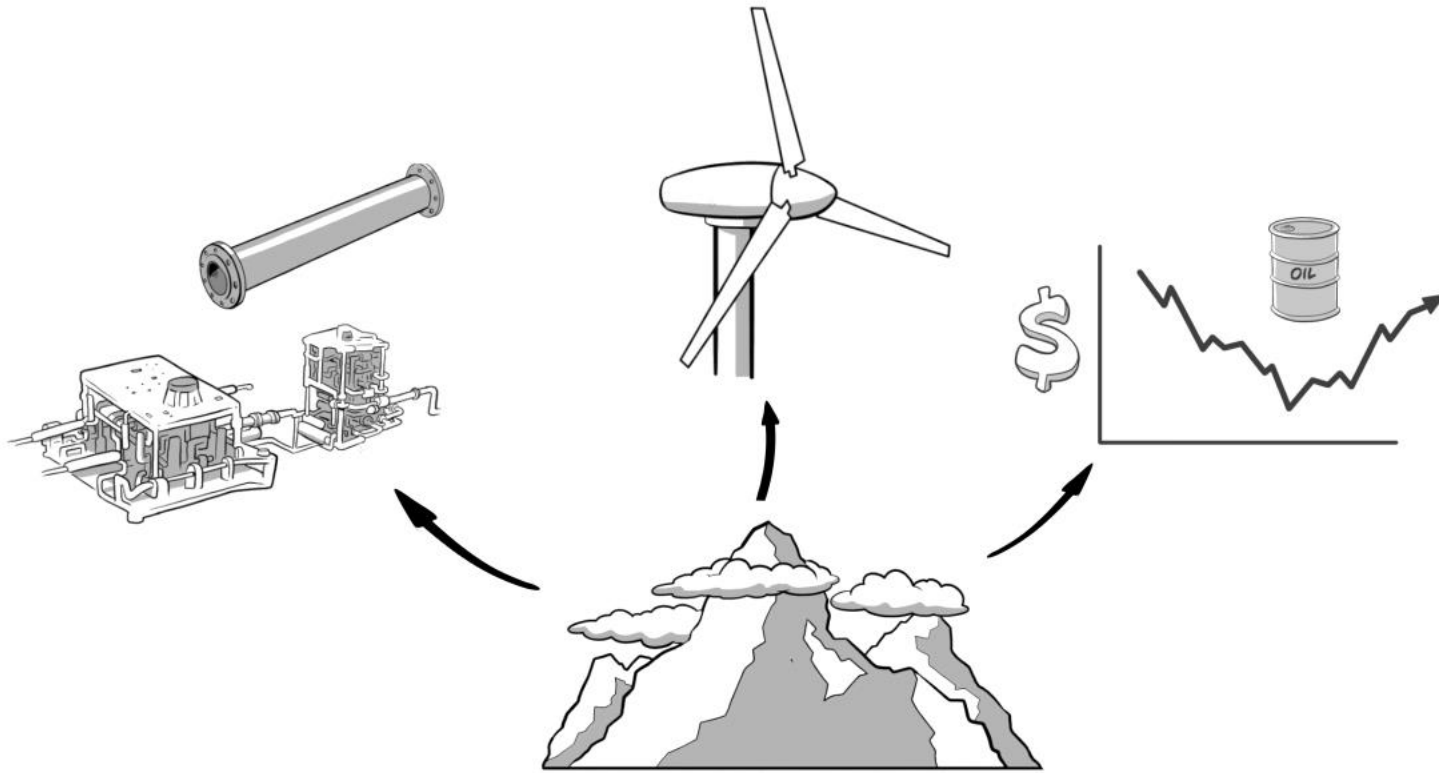

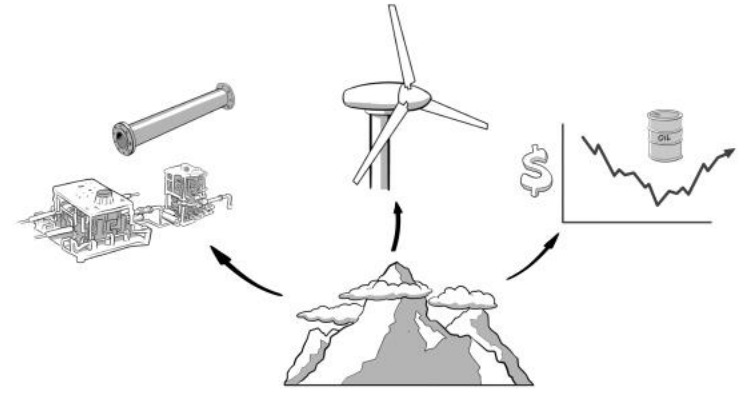

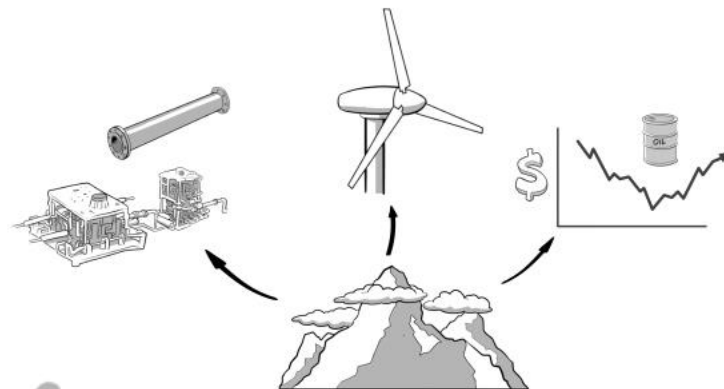
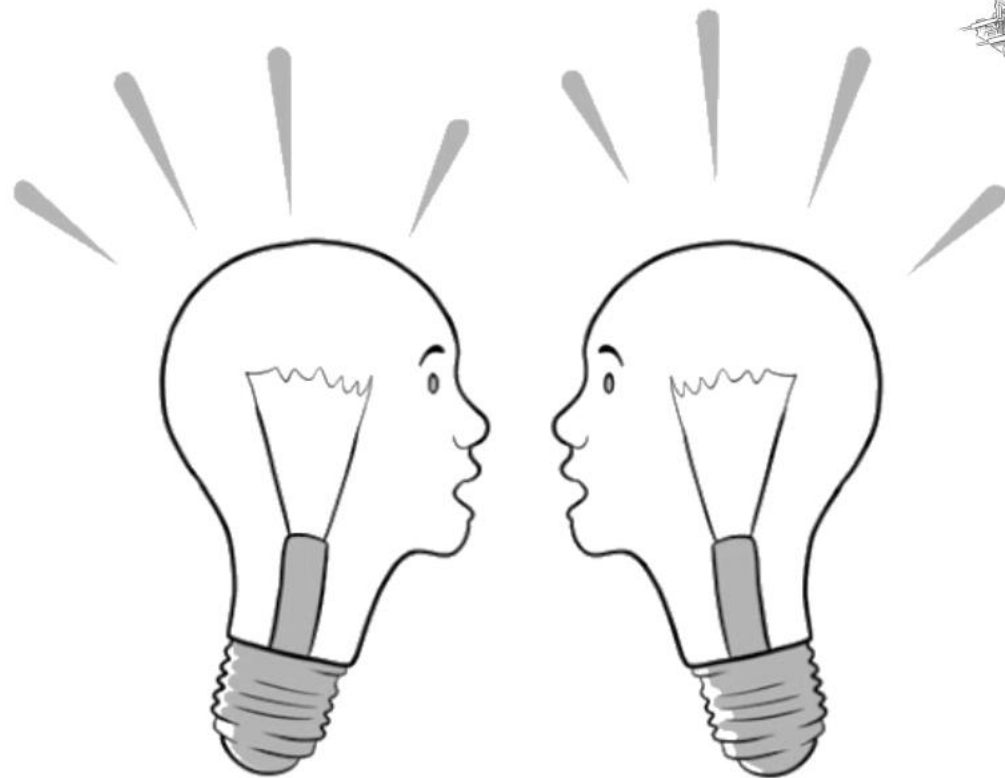

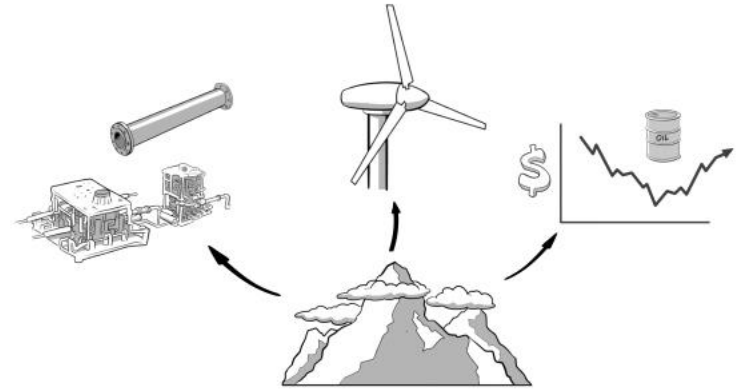
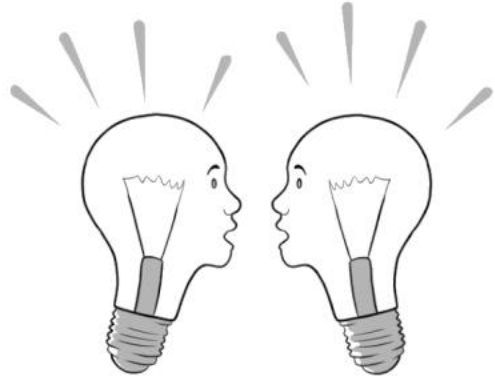

CAPABILITIES

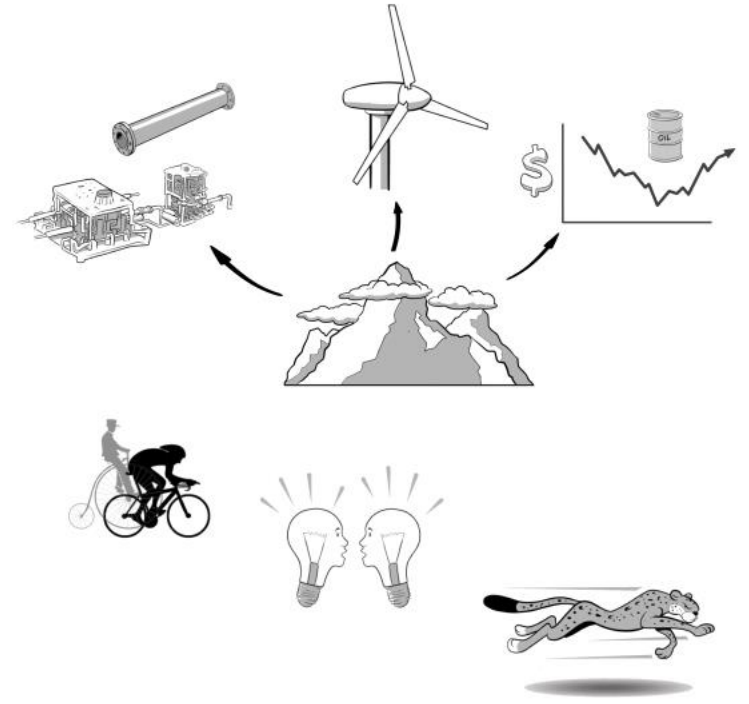

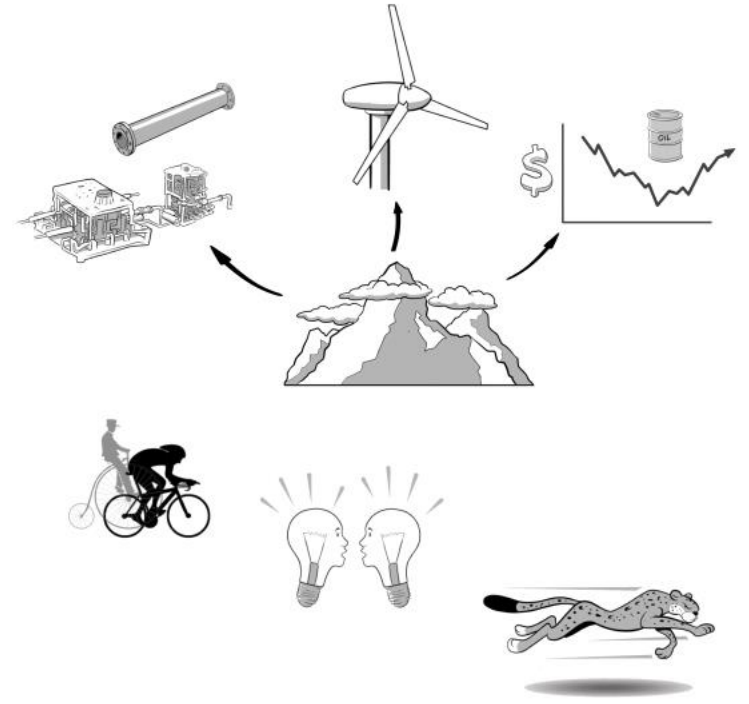
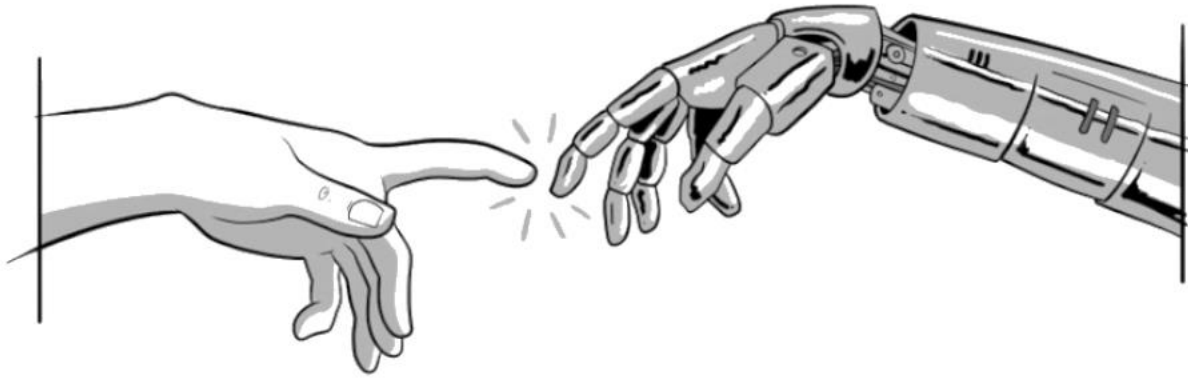

CAPABILITIES

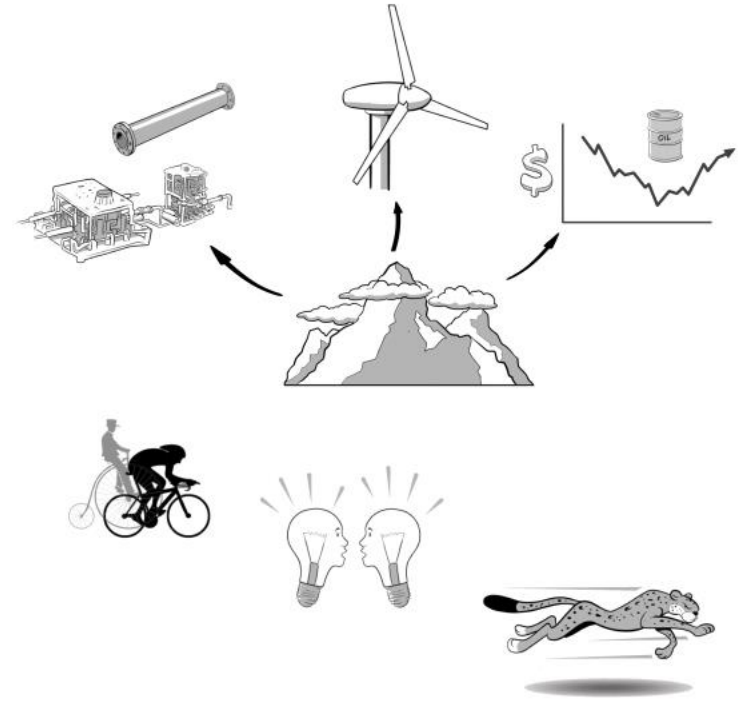
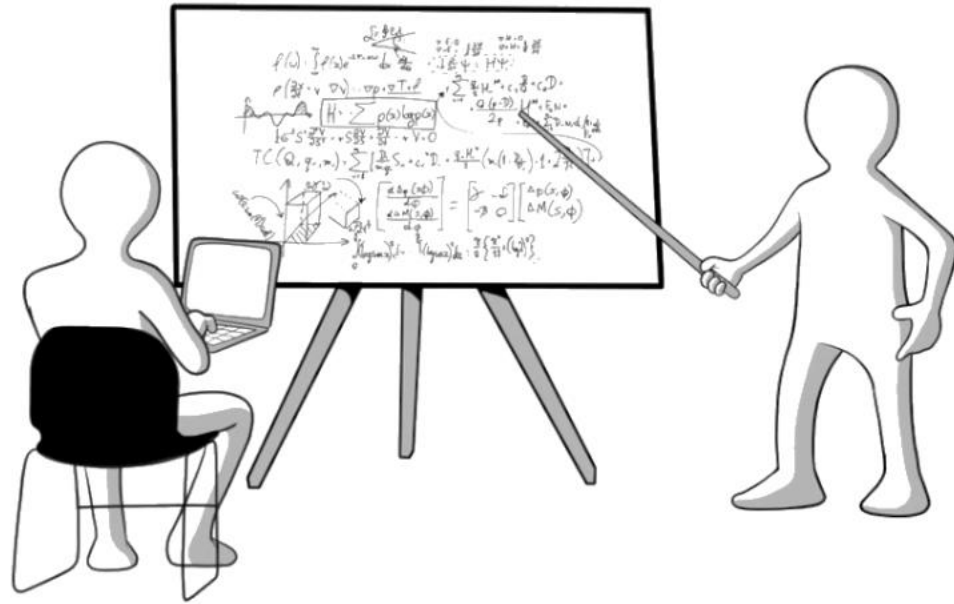

CAPABILITIES

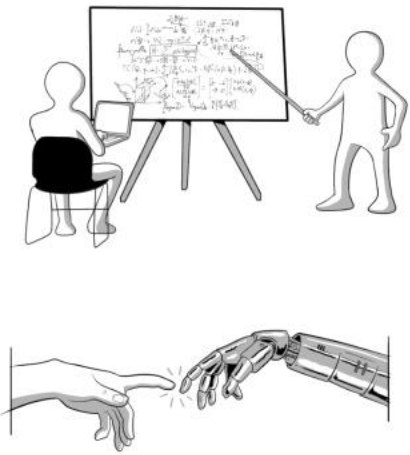
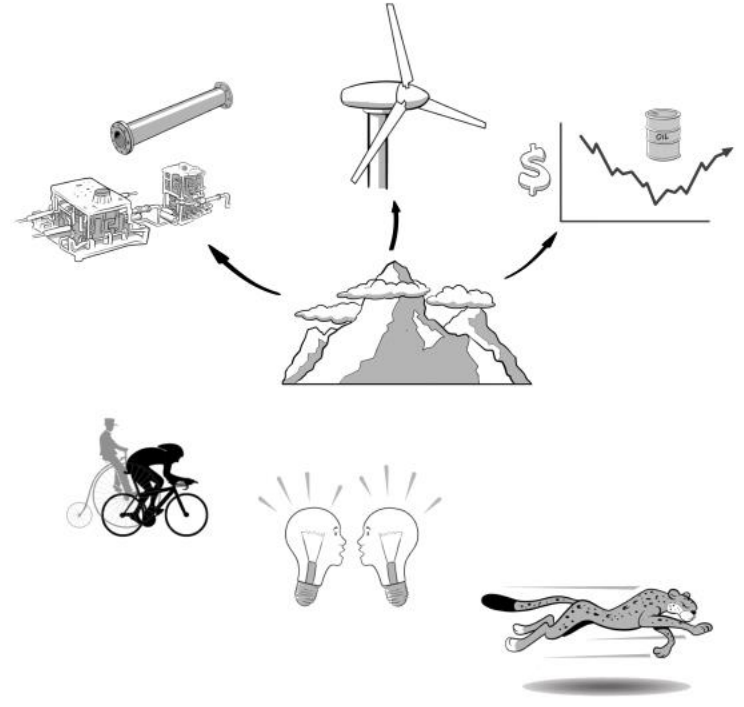

CAPABILITIES

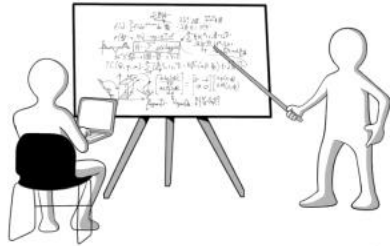
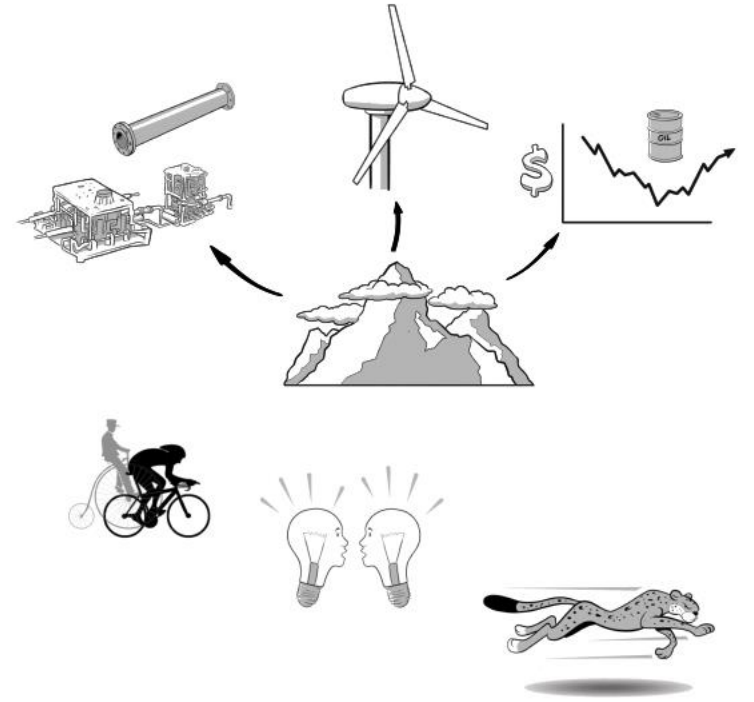
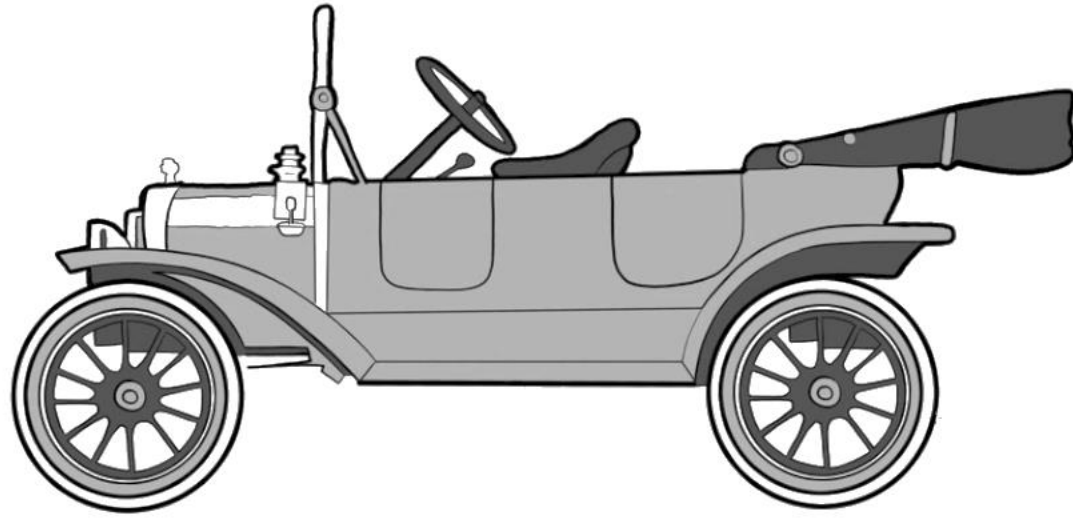

CAPABILITIES

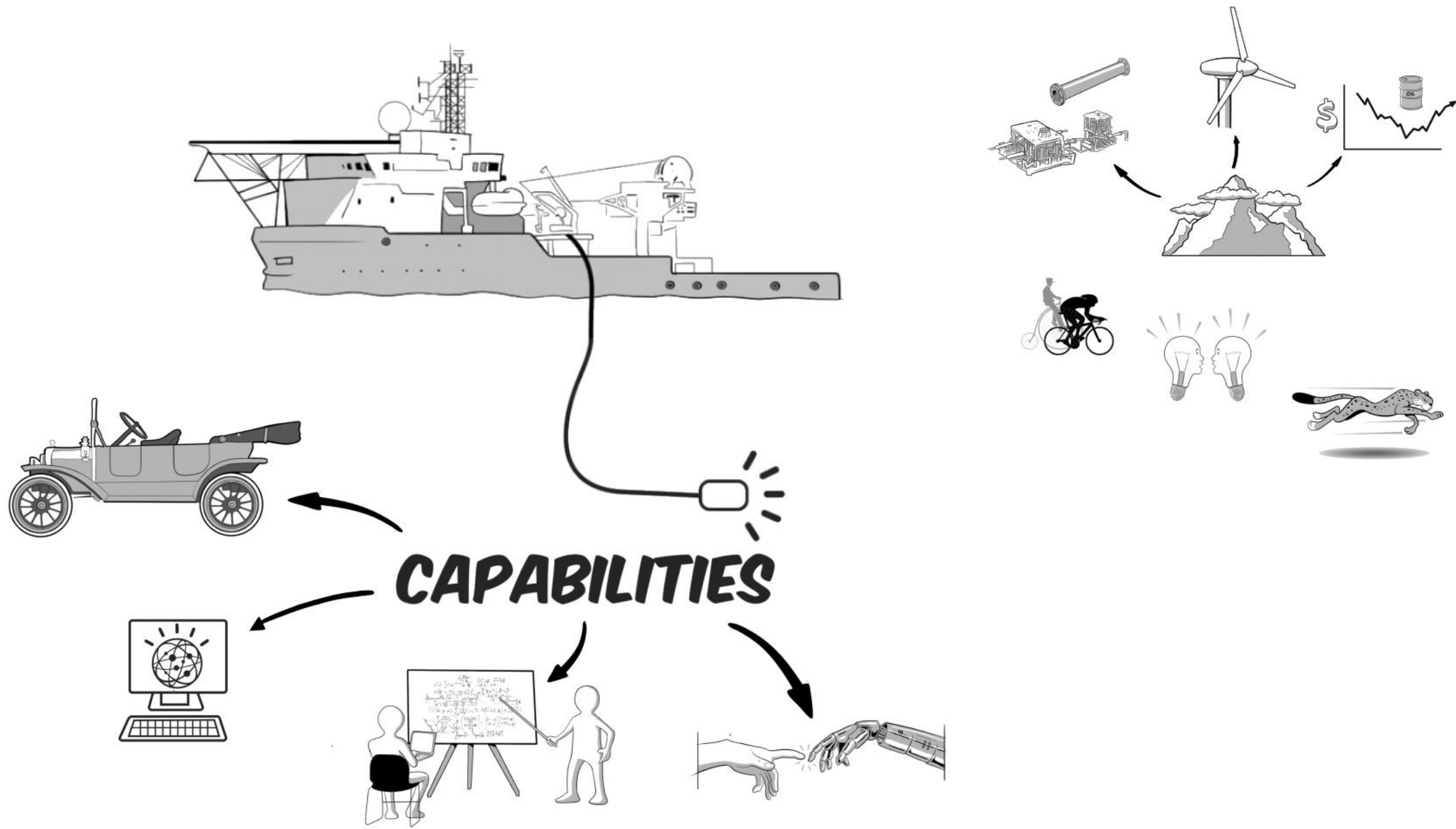

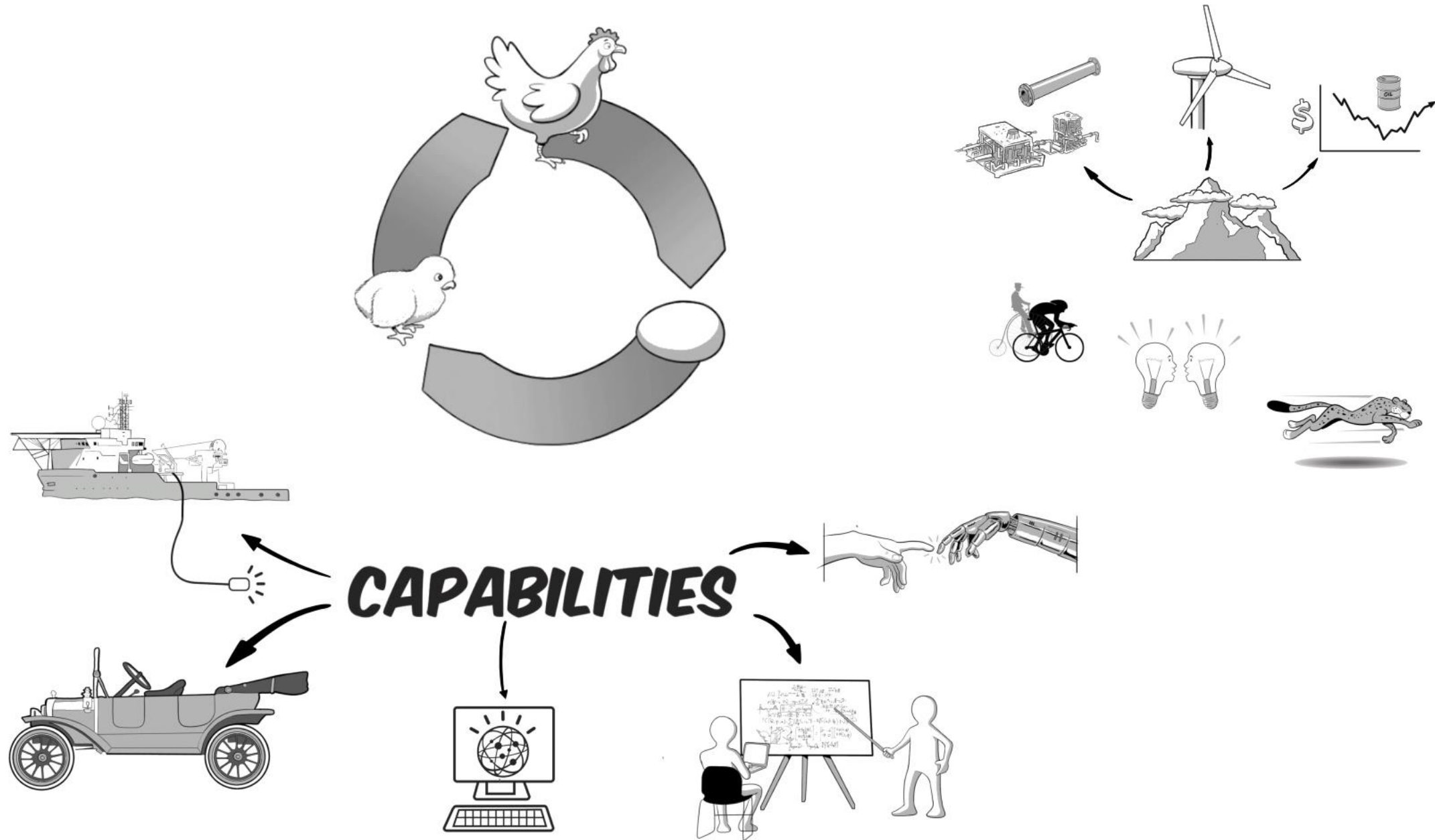

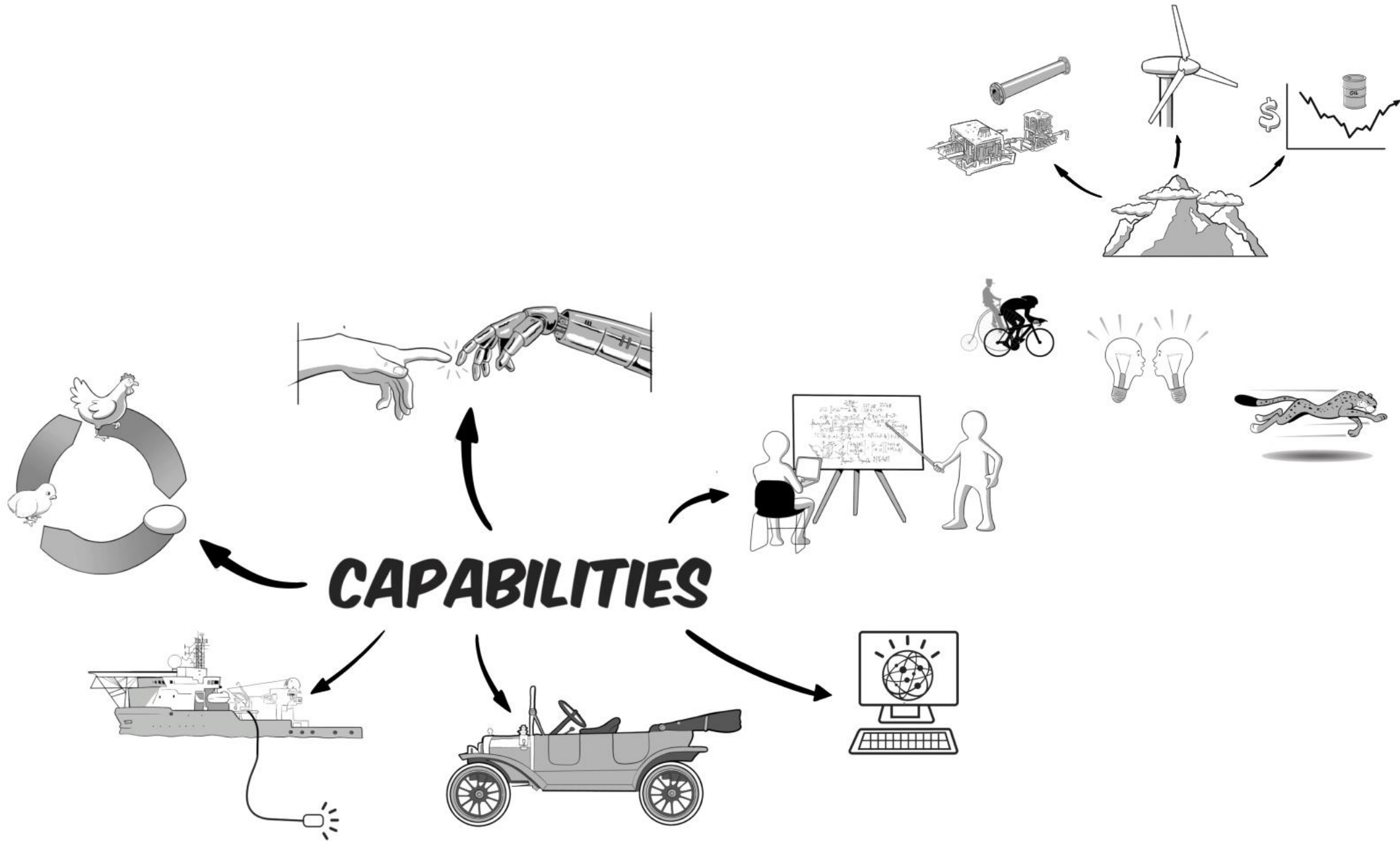

OTHER OPPORTUNITIES

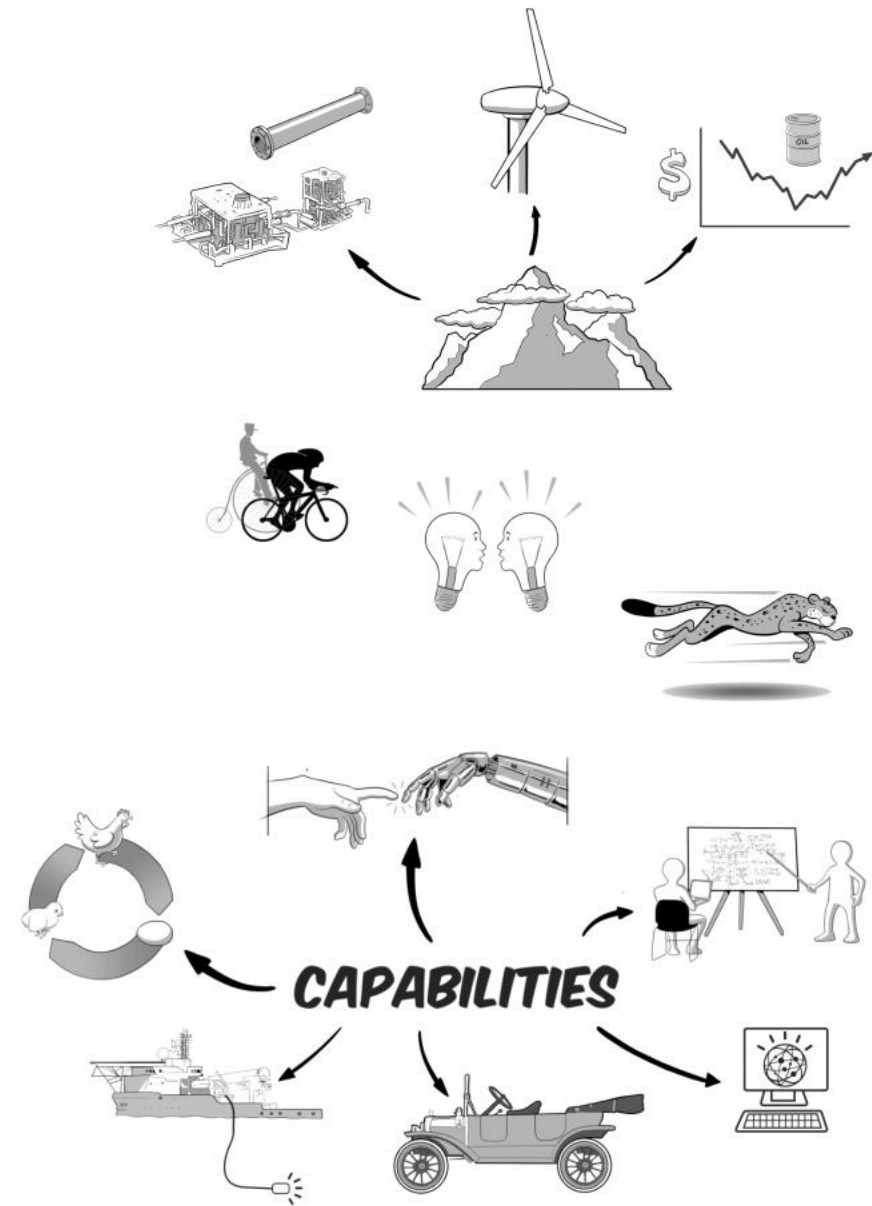



OTHER OPPORTUNITIES

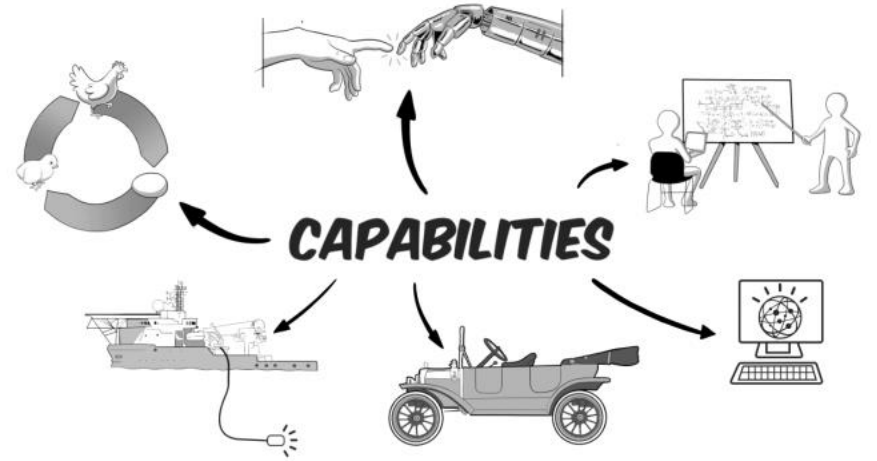
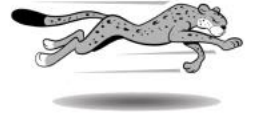
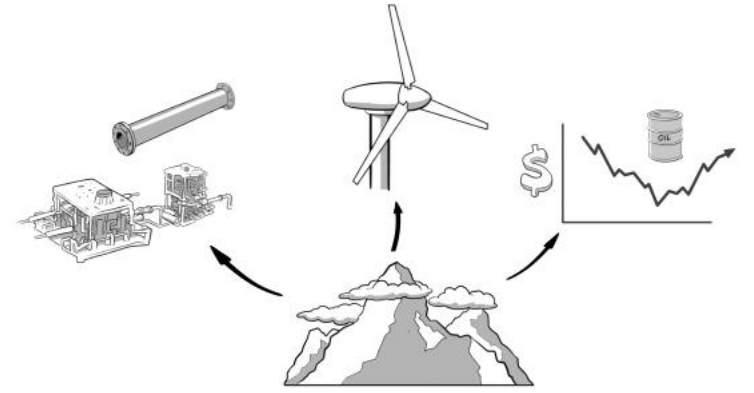



OTHER OPPORTUNITIES

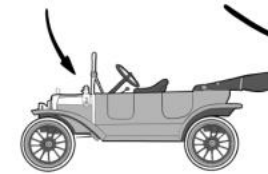
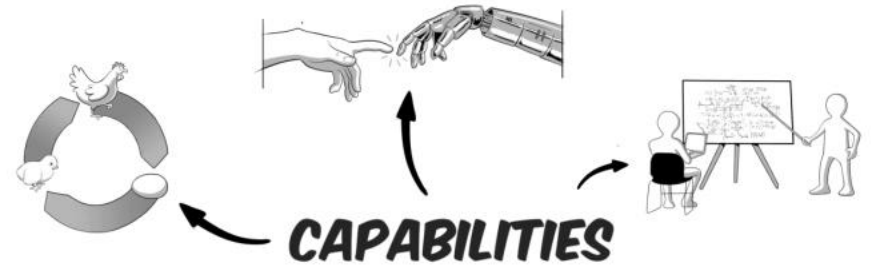
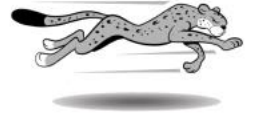
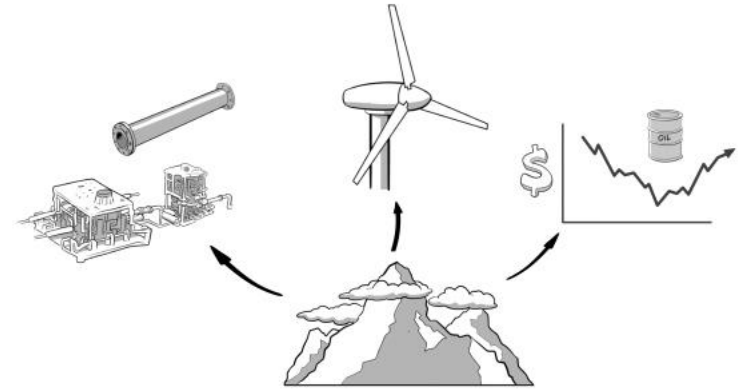

LNG 9N7

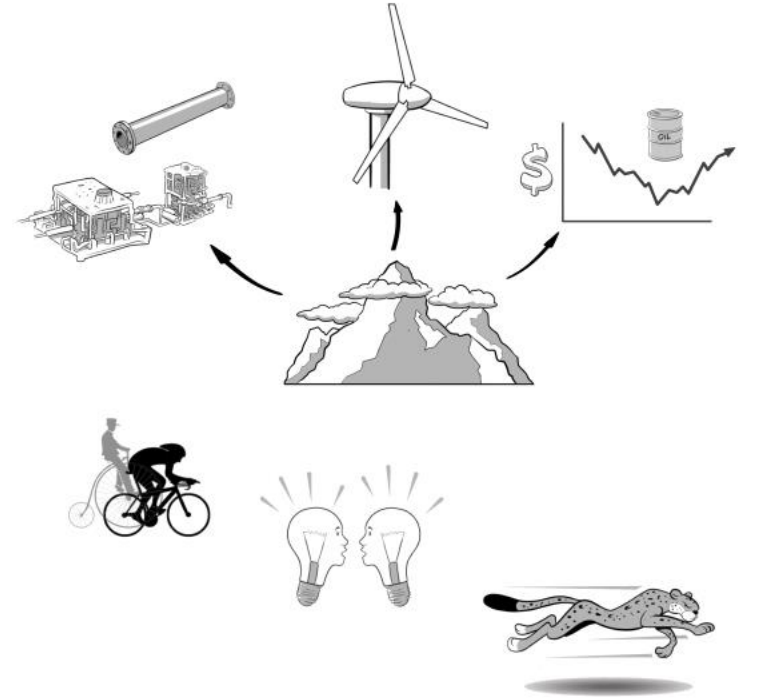
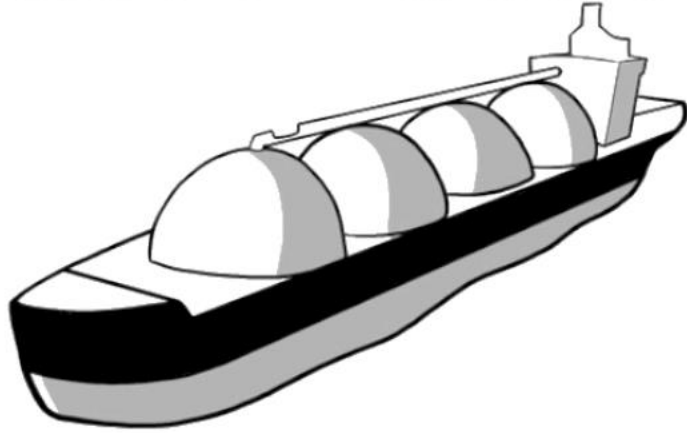

OTHER OPPORTUNITIES

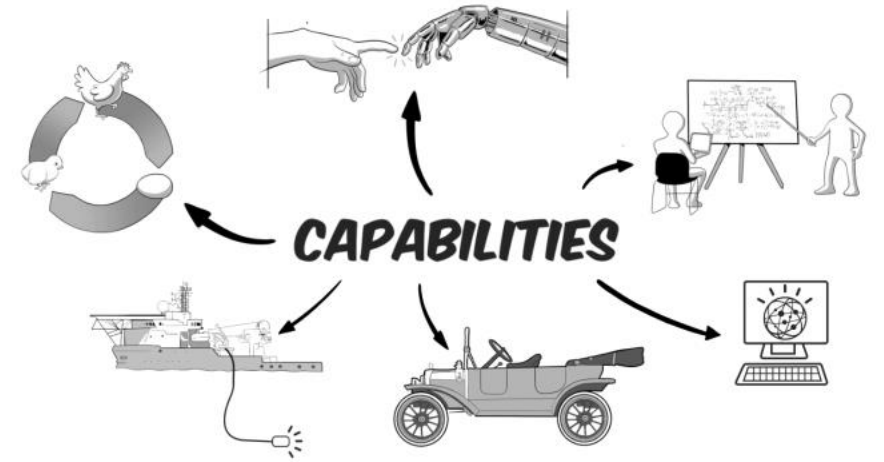
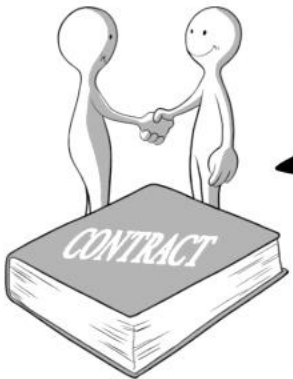

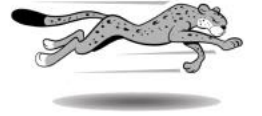
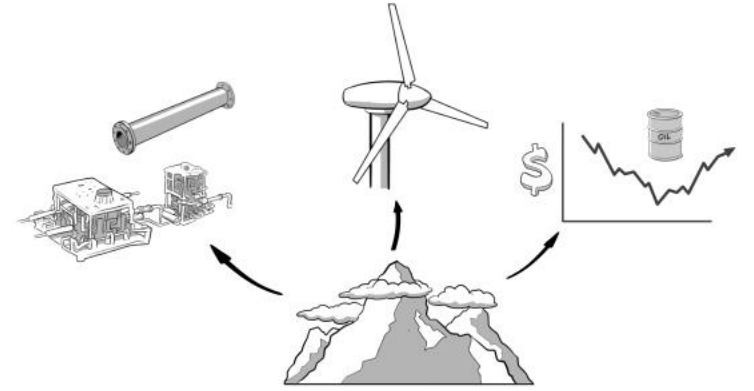

LNG 5N1

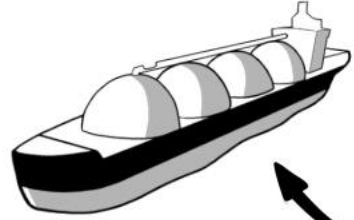

OTHER OPPORTUNITIES

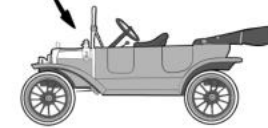
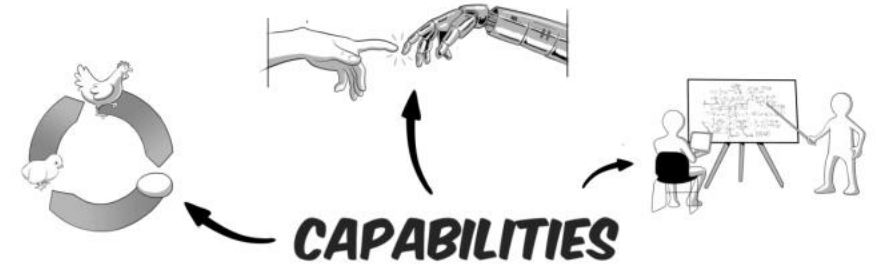

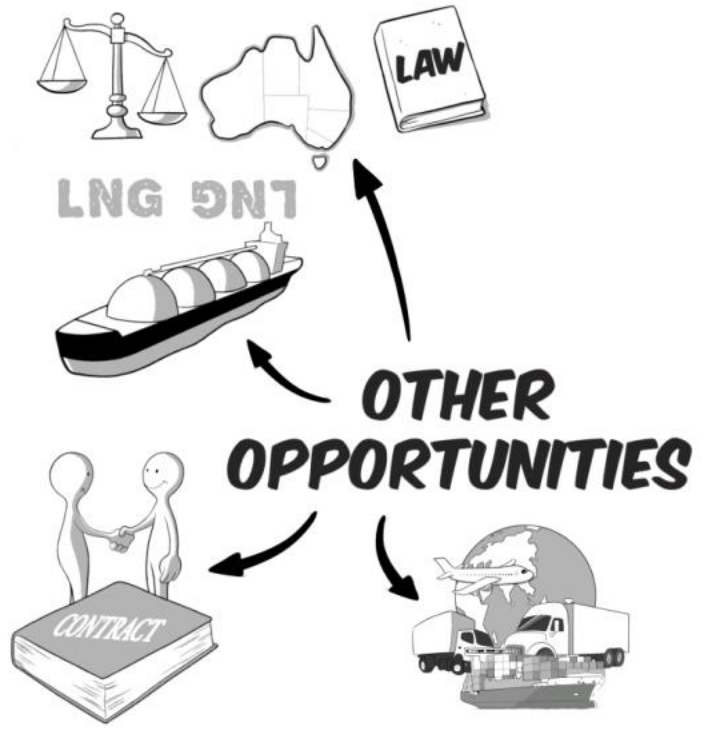
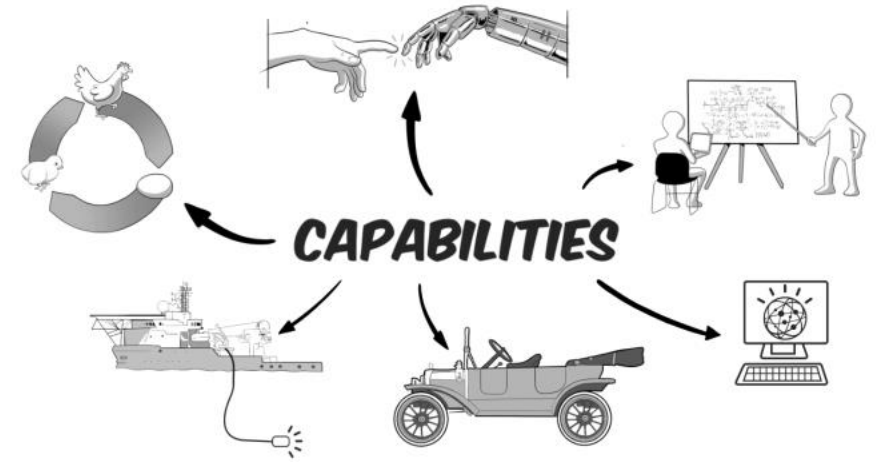
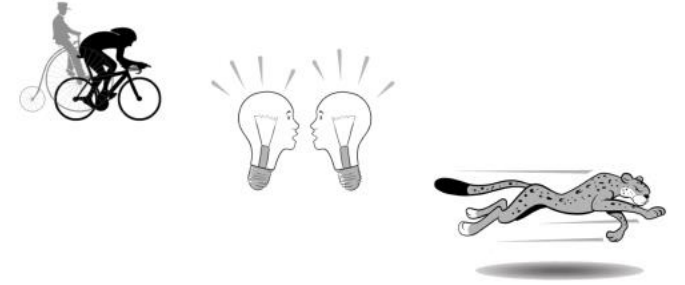
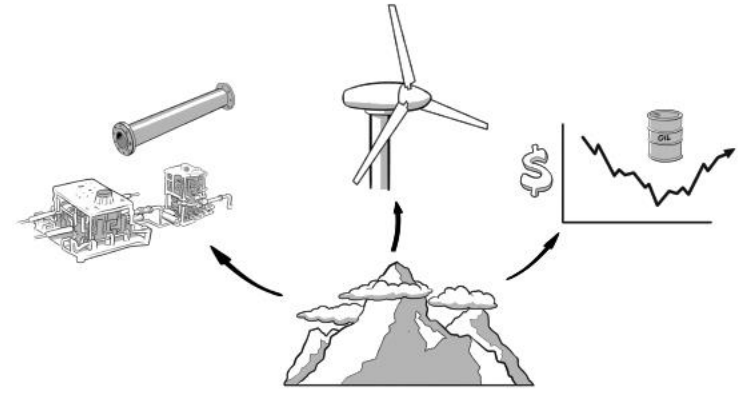

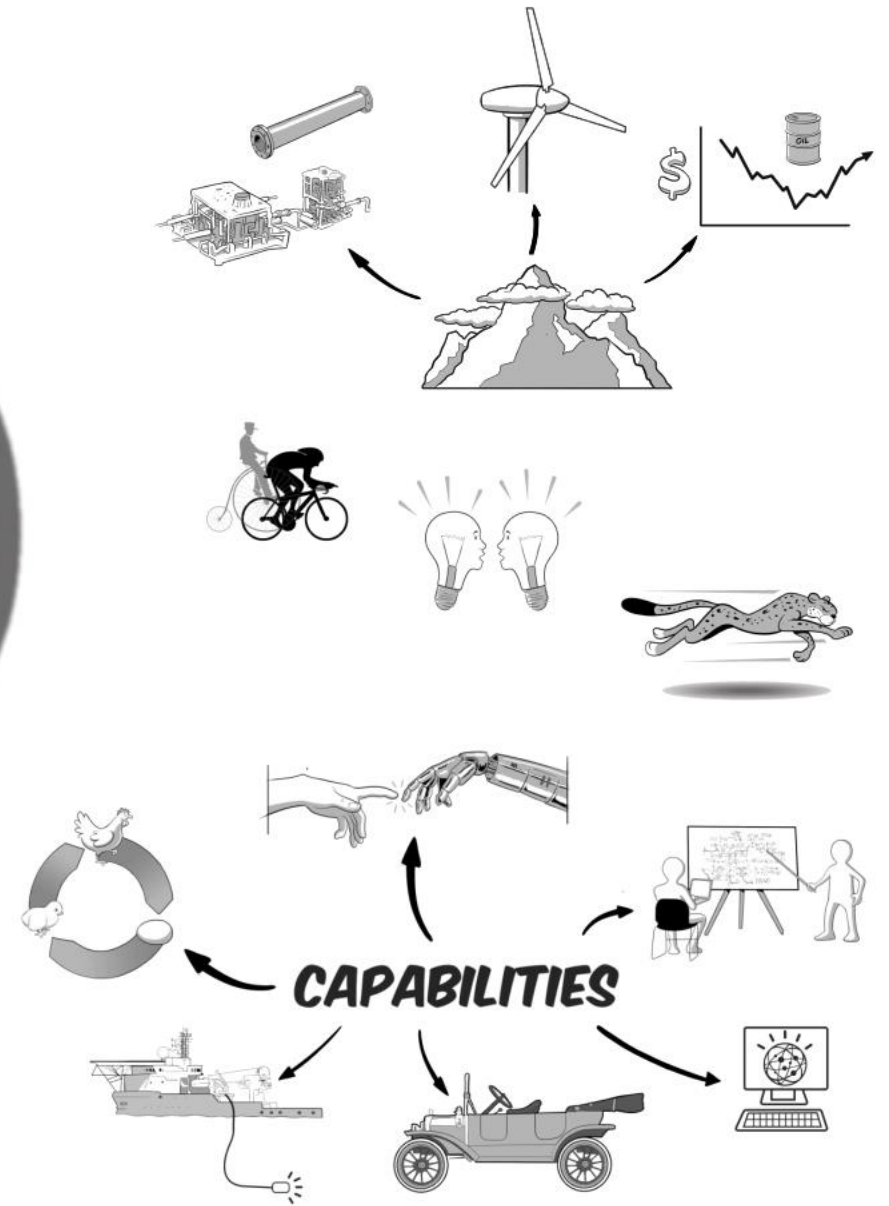
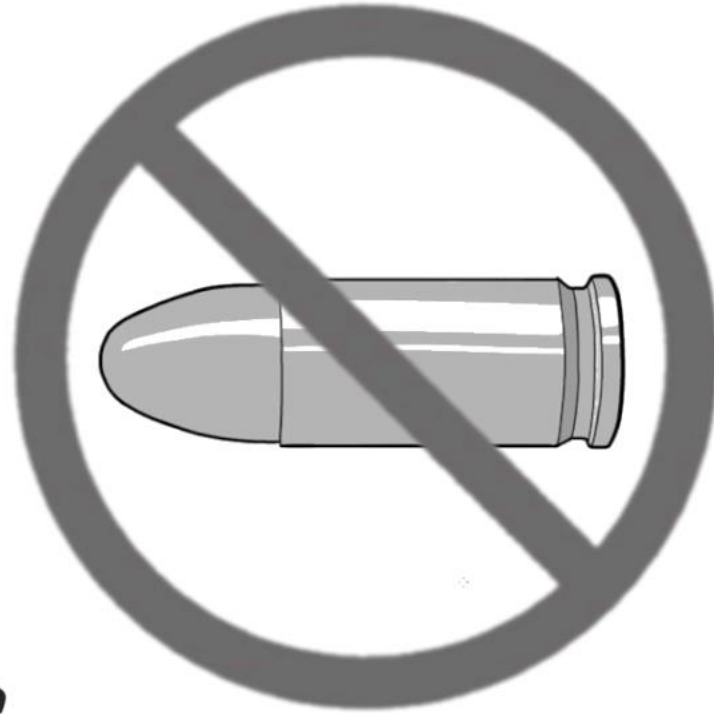
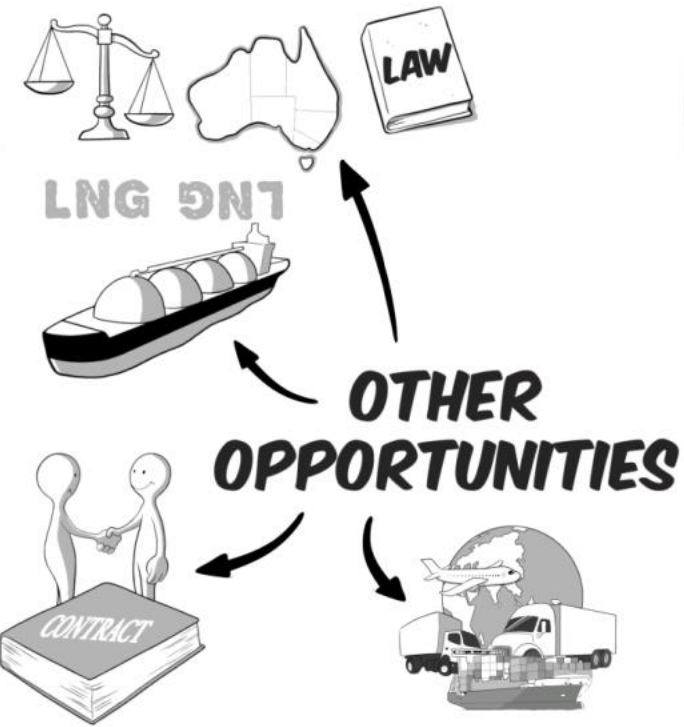

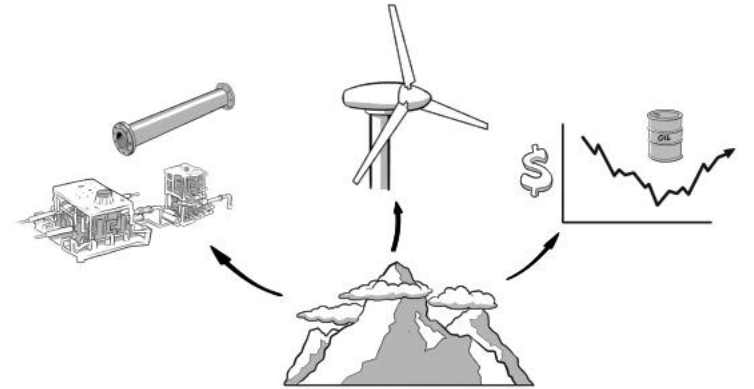

LNG 5NT

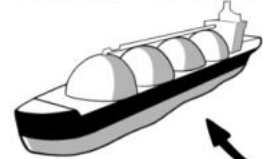

OTHER OPPORTUNITIES

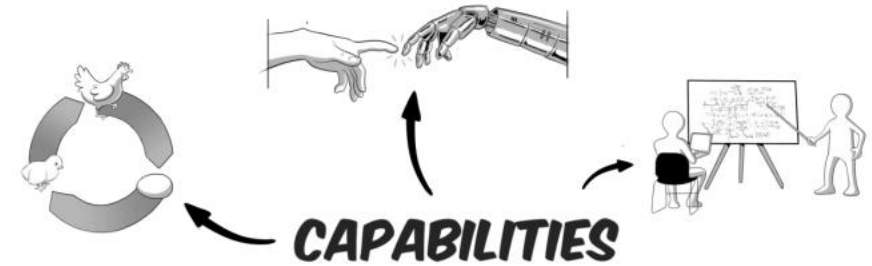

CAPABILITIES

